

# BEKO

installation & operating Condenser  
instructions and drying guidance Sensor Dryer

DRCS 76 W  
DRCS 76 S



get the **best** from your new tumble dryer

## **Please read this manual first!**

Dear Customer,

We hope that your product which has been manufactured in modern facilities and passed through a strict quality control procedure will give you the best results.

Therefore, we advise you to read through this manual carefully before using your product and keep it for future reference.

## **This operation manual will...**

...help you use your machine in a fast and safe way.

- Please read the Operation Manual before installing and starting your machine.
- Particularly follow the instructions related to safety.
- Keep this Operating Manual within easy reach. You may need it in the future.
- Please read all additional documents supplied with this machine.

Please note that this Operating Manual may be applicable for several other models. Differences between models will be identified in the manual.

## **Explanation of symbols**

Throughout this Operation Manual the following symbols are used:



### **Important safety information**

This is the general warning sign. It is used to alert the user to potential hazards. All safety messages that follow this sign shall be obeyed to avoid possible harm.



### **Caution, risk of electric shock**



### **Caution, risk of fire**



### **Caution, hot surface**



### **Read the instructions**



### **Useful information.**

Important information or useful hints about usage.

## TABLE OF CONTENTS

### **1 Your Dryer 4**

---

Overview .....4

### **2 Important Safety Instructions 5**

---

### **3 Installation 7**

---

Appropriate installation location .....7

Adjusting the feet.....7

Ventilation hose and connection  
(for products equipped with an  
outlet vent).....7

Connection to a water drain (for  
products equipped with a condenser ).8

Destroying the packaging material .....9

Disposing of the old machine.....9

### **4 Electrical Connection 10**

---

Electrical requirements.....10

Fitting a different plug .....10

Washer/dryer combination.....10

### **5 Initial preparations for drying 11**

---

Garments suitable for drying in the  
machine .....11

Garments unsuitable for drying in  
the machine.....11

Preparing clothes to be dried.....11

Correct load capacity .....11

Loading door.....12

### **6 Selecting a Programme and Operating Your Machine 13**

---

Control panel.....13

Turning the machine on .....13

Programme selection.....13

Programme selection and  
consumption table.....15

Auxiliary function.....16

Warning indicators.....16

Time delay.....16

Starting the Programme .....16

Progress of programme.....16

Changing the programme after  
the programme has started .....17

Child-proof lock.....17

Ending the programme through  
canceling.....17

Technical Specifications.....18

End of programme .....18

### **7 Quick instructions for daily use 19**

---

### **8 Maintenance and cleaning 20**

---

Cover filter .....20

Sensor (models equipped  
with a sensor) .....20

Water tank (Products equipped  
with a condenser); .....20

For the condenser (products  
equipped with a condenser); .....21

### **9 Solution suggestions for problems 22**

---

### **10 Door Reversal 23**

---

### **11 Guarantee 24**

---

### **12 Service 25**

---

# 1 Your Dryer

## Overview

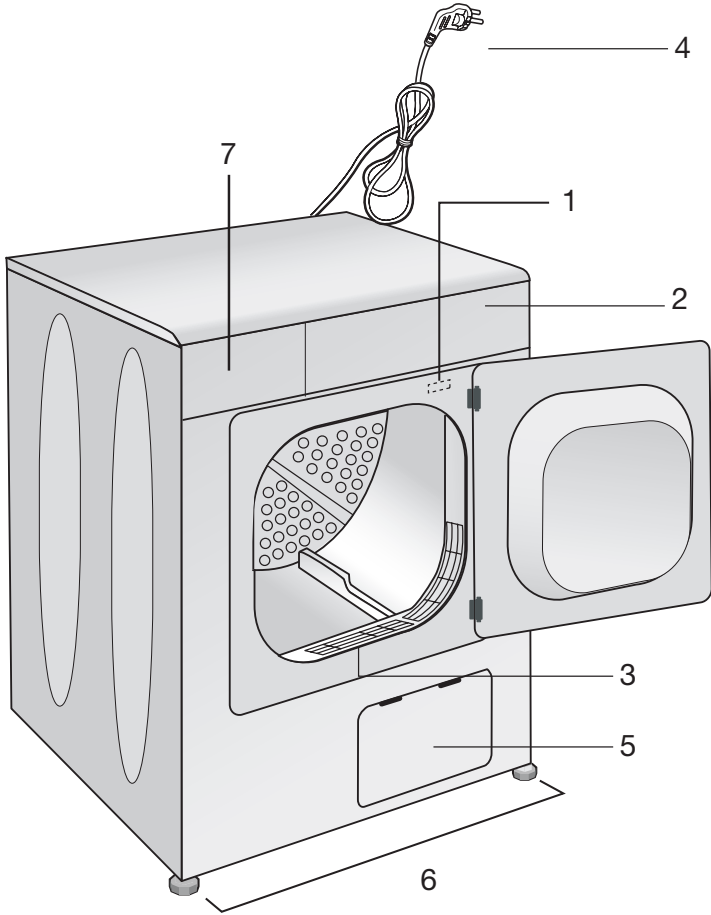

1- Type label

2- Control Panel

3- Lint filter

4- Power Cord

5- Condenser and water tank cover

6- Adjustable Feet

7- Water tank

Specifications of this appliance may change without notice to improve the quality of the product. Figures in this manual are schematic and may not match your product exactly. Values stated on the machine labels or in the documentation accompanying it are obtained in laboratory in accordance with the relevant standards. Depending on operational and environmental conditions of the appliance, values may vary.

## 2 Important Safety Instructions

---

**⚠ WARNING: To reduce the risk of fire, electric shock, or injury to persons when using your appliance, follow basic precautions including the following:**

- Read all instructions before using the appliance. Otherwise, there may be the risk of personal injury or material damage. Moreover, any warranty and reliability commitment will become void.

**⚠ This product has been designed for home use only.**

- Your machine can be operated at temperatures between +5°C and +35°C.
- The appliance must not be installed behind a lockable door, a sliding door or a door with a hinge on the opposite side to that of the tumble dryer.
- Do not install or store this appliance where it will be exposed to the weather.
- Do not tamper with controls.
- Do not repair or replace any part of the appliance or attempt any servicing unless specifically recommended in the user-maintenance instructions or in published user-repair instructions that you understand and have the skills to carry out.
- Unplug the machine when it is not in use.
- Never wash down the appliance with water! There is the risk of electric shock!
- Never touch the plug with wet hands.
- Never pull from the cable to unplug the machine.
- Do not operate the machine if the power cord or plug is damaged.
- Never attempt to repair the machine yourself.
- For malfunctions that cannot be solved by information in the operating manual: Turn off and unplug the appliance and call an authorized service agent.

- This appliance must be grounded. In the event of malfunction or breakdown, grounding will reduce the risk of electric shock by providing a path of least resistance for electric current. This appliance is equipped with a cord having an equipment-grounding conductor and a grounding plug. The plug must be plugged into an appropriate outlet that is properly installed and grounded in accordance with all local codes and ordinances.

**⚠ WARNING: Improper connection of the equipment-grounding conductor can result in a risk of electric shock. Check with a qualified electrician or service representative or personnel if you are in doubt as to whether the appliance is properly grounded.**

- Power cord plug must be within easy reach after installation.
- To reduce the risk of fire or electrical shock, do not use extension cords, multi-plugs or an adapter to connect the dryer to electrical mains.
- Do not modify the plug provided with the appliance: if it will not fit the outlet, have a proper outlet installed by a qualified electrician.
- If the supply cord is damaged, it must be replaced by the manufacturer, its service agent or similarly qualified persons in order to avoid a hazard.
- The appliance must not be operated unless it is repaired! There is the risk of electric shock!
- Ventilation openings in the base must not be obstructed by a carpet, etc.
- Exhaust air must not be discharged into a flue, which is used for exhausting fumes from appliances burning gas or other fuels.
- Adequate ventilation has to be provided to avoid the back flow of gases into the room from appliances burning other fuels, including open fires.

- Do not dry articles that have been previously cleaned in, washed in, soaked in or spotted with petrol/gasoline, dry-cleaning solvents or other flammable or explosive substances as they give off vapors that could ignite or explode.
- Do not use the tumble dryer if industrial chemicals have been used for cleaning.
- Do not dry unwashed items in the tumble dryer.
- Items that have been soiled with substances such as cooking oil, acetone, alcohol, petrol, kerosene, spot removers, turpentine, waxes and wax removers should be washed in hot water with an extra amount of detergent before being dried in the tumble dryer.
- Items such as foam rubber (latex foam), shower caps, waterproof textiles, rubber backed articles and clothes or pillows fitted with foam rubber pads should not be dried in the tumble dryer.
- Do not use fabric softeners or products to eliminate static unless recommended by the manufacturer of the fabric softener or product.
- The appliance may only be used for drying of textiles that are marked accordingly.
- Undergarments that contain metal reinforcements should not be placed in a tumble dryer. Damage to the tumble dryer can result if metal reinforcements come loose during drying.
- Check all garments for forgotten lighters, coins, metal pieces, needles, etc. before loading.
- Fabric softeners, or similar products, should be used as specified by the fabric softener instructions.
- The final part of a tumble dryer cycle occurs without heat (cool-down cycle) to ensure that the items are left at a temperature that ensures that the items will not be damaged.

**⚠ WARNING: Never stop the tumble dryer before the end of the drying cycle unless all items are quickly removed and spread out so that the heat is dissipated.**

- Do not reach into the appliance if the drum is moving.
- Do not allow children to play on or in the appliance.
- Young children should be supervised to ensure that they do not play with the appliance.
- Before the appliance is removed from service or discarded, remove the door to the drying compartment.
- Close the loading door when you leave the area where the machine is located.
- This appliance is not intended for use by persons (including children) with reduced physical, sensory or mental capabilities, or lack of experience and knowledge, unless they have been given supervision or instruction concerning use of the appliance by a person responsible for their safety.
- Clean lint screen before or after each load.
- Keep area around the exhaust opening and adjacent surrounding areas free from the accumulation of lint, dust, and dirt.
- The interior of the appliance and exhaust duct should be cleaned periodically by qualified service personnel.
- Never use the dryer without the lint filter.

**SAVE THESE INSTRUCTIONS**

## 3 Installation

### Appropriate installation location

- Install your machine in environments which have no risk of freezing and in a stable and level position.
- Do not place your machine on a long pile rug or on similar surfaces.
- Operate your machine in a well ventilated, dust-free environment.
- Do not block the air ducts in front of and under the machine with materials such as long pile rugs or kitchen unit plinths.

⚠ Make sure that your machine is not placed on the power cable.

⚠ Keep at least 3 cm from the edges of other furniture.

### Under Counter Installation

- Leave at least 3 cm of space between the side and rear walls of the machine and the walls of the counter/cupboard when installing your machine under a counter or in a cupboard. Never use the tumble dryer without top plate.

### Adjusting the feet

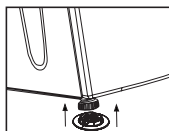

In order to ensure that your machine operates more silently and vibration-free, it must stand level and balanced on its feet. Front feet of your machine can be adjusted. Balance the machine by adjusting the feet.

1. Loosen the feet by hand.
2. Adjust them until the machine stands level and firmly.

ⓘ Do not use any tools to loosen the adjustable feet. Otherwise, they can be damaged.

ⓘ Never unscrew the adjustable feet from their housings.

2 plastic pieces supplied together with the Operating Instructions prevent your machine from slipping on wet and slippery surfaces. To install these plastic parts:

1. Tilt your machine to backwards.
2. Fit the plastic parts to the front adjustable feet. Press on the plastic parts to fix them in their places.
3. Check the balance of your machine again and readjust the adjustable feet if necessary.

### Ventilation hose and connection (for products equipped with an outlet vent)

Ventilation hose assures exhausting of the air from inside the machine.

Vented dryer has 1 air outlet.

Stainless sheet metal or aluminum pipes can be used instead of the hose. The diameter of the pipe to be used should be minimum 10 cm.

Maximum hose and pipe lengths are given in the table below.

	Hose	Pipe
Maximum length	4 m	5 m
1 elbow 45°	-1.0 m	-0.3 m
1 elbow 90°	-1.8 m	-0.6 m
1 elbow 90° short		-2.7 m
1 wall passage	-2.0 m	-2.0 m

ⓘ Each elbow and other passages should be subtracted from the above maximum length.

To connect a ventilation hose;

1. Connect the air outlet hose to the hose spacer piece by turning it anti-clockwise.
2. Make the hose passages as shown below.

**i** Exhaust of humid air from the dryer into the room is inconvenient. It may damage the walls and furniture in the room.

**i** The ventilation hose can be routed outdoors via a window or it can be connected to an air outlet in the wall (see diagram below).

**i** Air outlet hose must be extended directly to the outdoors. There must be a small number of elbows as not to hinder air ventilation.

**i** To prevent water accumulation in the hose, make sure that it is not folded on the floor.

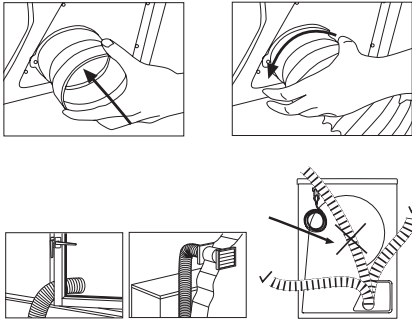

**⚠** The air ventilation hose should not be connected to the chimney of a stove or a fireplace.

**⚠** Do not operate your machine at the same time with heaters such as a coal or gas stove. Airflow may cause the chimney to flare up. Airflow may cause the chimney to flame up.

## Connection to a water drain (for products equipped with a condenser)

In products equipped with a condenser unit the water accumulated during the drying cycle is collected in the water tank. You should drain the accumulated water after each washing cycle.

You can directly send the accumulated water out through the water drain hose supplied with the machine instead of periodically draining the water collected in the water tank.

Connecting the water drain hose;

1. Remove the hose on the machine by pulling it out from its end. Do not use any tools to take out the hose. Attach the drain hose adaptor to the end of this hose.
2. Connect the special drain hose supplied with the machine to the hose adaptor fitting.
3. The other end of the drain hose can be directly connected to the wastewater drain or to the washbasin. The fitting must always be secured in all types of connections. Your house may be flooded if the hose gets out of its housing during water discharge.

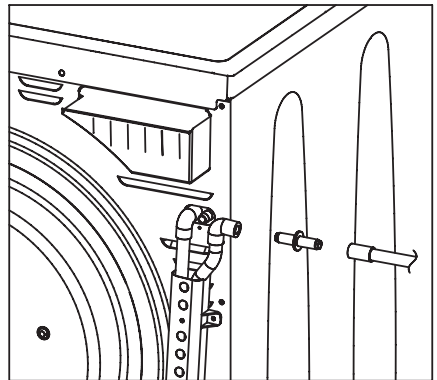

**i** When you direct the water drain out, “Water Tank” warning LED will light up at the end of each programme.

Important:

- The hose should be attached to a height of maximum 80 cm.
- You must be careful not to pinch or bend the hose.
- The end of the hose should not be bent, it should not be stepped on and it must not be folded between the drain and the machine.



## **Destroying the packaging material**

Packaging material can be dangerous to children. Keep the packaging materials out of the reach of children or dispose of them accordingly. Do not dispose them together with normal domestic wastes. Packaging materials of your machine are manufactured from recyclable materials.

## **Disposing of the old machine**

Dispose of your old appliance in an environmental friendly manner.

- You may refer to your local agent or solid waste collection center in your municipality to learn how to dispose of your machine.

Before disposing of your old washing machine, cut off the mains plug and make the door lock unusable.

## 4 Electrical Connection

Make sure that you have an earthed power outlet socket rated at 13 amps (minimum).

### Attention!

If you use your dryer as built-in, the socket must be reachable after installation, or a separate switch (which can disconnect the two poles) must be used in the installation. Check for suitability.

For a permanent connection, a master switch with at least 3mm contact clearance and minimum 13 A rating must be used.

### Electrical requirements

Before you insert the plug into the wall socket make sure that the voltage and the frequency shown in the rating label corresponds to your electricity supply. We recommend that this appliance be connected to the mains supply via a suitable switched and fused socket in a readily accessible position. Should the mains lead of the appliance become damaged or need replacing at any time, it must be replaced by a special purpose made mains lead which can only be obtained from a Authorised Service Agent.

### Warning

#### This appliance must be earthed

If the fitted moulded plug is not suitable for your socket, then the plug should be cut off and an appropriate plug fitted. The moulded plug on this appliance incorporates a 13A fuse. Should the fuse need to be replaced an ASTA approved BS1362 fuse of the same rating must be used. Do not forget to refit the fuse cover. In the event of losing the fuse cover, the plug must not be used until a replacement fuse cover has been fitted. Colour of the replacement fuse cover must be the same colour as that visible on the pin face of the plug. Fuse covers are available from any good electrical store.

In order to avoid hazards, damaged supply cord should be replaced by the manufacturer, its service agent or similarly qualified people.

### Built-under installation

This appliance can be installed under a worktop.

⚠ Only authorised specialists are permitted to carry out a built-under installation. Risk of electric shock!

### Important

#### Fitting a different plug

As the colours of the wires in the mains lead of this appliance may not correspond with the coloured markings identifying the terminals on your plug, proceed as follows:

- 1 Connect the green - yellow or green (earth) wire to the terminal in the plug marked 'E' or with the symbol  or coloured green and yellow or green.
- 2 Connect the blue (neutral) wire to the terminal in the plug marked 'N' or coloured black.
- 3 Connect the brown (live) wire to the terminal in the plug marked 'L' or coloured red.

With the alternative plugs a 13A fuse must be fitted either in the plug or adaptor or in the main fuse box. If in doubt contact a qualified electrician.

### Washer/dryer combination

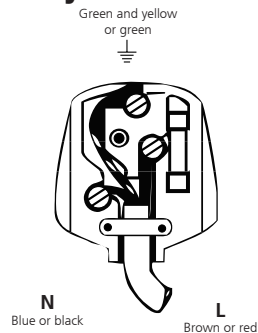

Do not stack washing machine on top of the tumble dryer. This would damage both appliances and guarantees would become void. It is also unsafe to stack an appliance on top of another without using a suitable and approved stacking kit obtained from the manufacturer of the appliances.

- A special stacking kit is required as an optional extra please contact customer service.

## 5 Initial preparations for drying

### Garments suitable for drying in the machine

Always follow the advice on the garment labels. With this dryer, dry only the laundry having a label stating that they are suitable for drying in a dryer by selecting the appropriate programme.

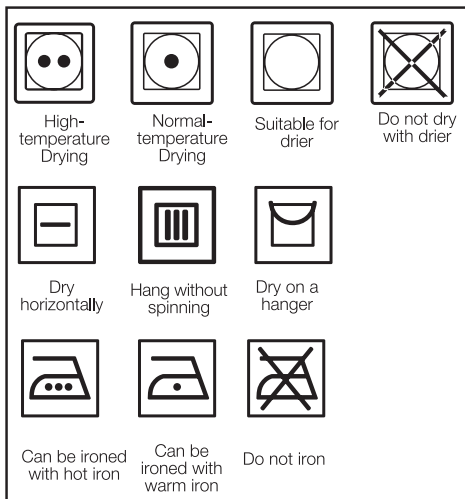

### Garments unsuitable for drying in the machine

- Laundry items and attachments made of or contain metal, hard plastic and similar materials, such as belt buckles, jeans, bra wires, buttons and similar accessories will damage your machine and may cause breakdown. So do not place such items in the tumble dryer. If you are in doubt, please call Customer Help Line.
- Do not dry items such as woolen, silk garments and nylon stockings, delicate embroidered fabrics, garments with metal accessories and items such as sleeping bags in the machine.
- Garments made of delicate and valuable fabrics as well as lace curtains can be creased. Do not dry these in your machine!
- Do not dry items made of hermetic fibers such as pillows and quilts in the drying machine.

- Garments made of foam or rubber may be deformed.
- Do not dry clothes containing rubber in the machine.
- Do not dry clothes exposed to petroleum, oil, combustible or explosive agents in the machine even if they are washed beforehand.
- Overly wet laundry or laundry with dripping water must not be put into the machine.

### Preparing clothes to be dried

- All laundry must be spun at the highest possible spin speed your washing machine allows for the textile type.
- Laundry may be tangled after washing. Separate your laundry before placing them into your dryer.
- Sort your laundry according to their types and thicknesses. Dry the same type of laundry together. E.g.: fine kitchen towels and table cloths dry faster than the thick bath towels.

### Correct load capacity

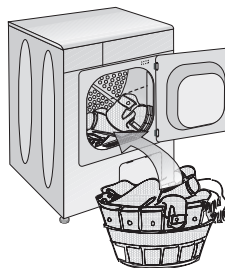

- ⚠ Please consider the information in the "Programme Selection Table". Always start the programme in accordance with the maximum load capacity.
- ℹ Adding laundry to the machine more than the level shown in the figure is not recommended. Drying performance will degrade when the machine is overloaded. Furthermore, your machine and your clothes might be damaged.

- ❗ Place your garments into the drum loosely so that they will not get tangled..
- ❗ Large pieces (E.g.: bed sheets, quilt covers, large tablecloths) may bunch-up. Stop the machine 1-2 times during drying process to separate bunched-up laundry.

Following weights are given as examples.

Home articles	Approximate weights (gr)
Cotton quit covers (double)	1500
Cotton quit covers (single)	1000
Bed sheets (double)	500
Bed sheets (single)	350
Large tablecloths	700
Small tablecloths	250
Tea napkins	100
Bath towels	700
Hand towels	350
Garments	Approximate weights (gr)
Blouses	150
Cotton shirts	300
Shirt	200
Cotton dresses	500
Dresses	350
Jeans	700
Handkerchiefs	100
T-Shirts	125

## Loading door

- Open the loading door.
- Place laundry items loosely into the machine.
- Push the loading door to close. Ensure that no items are caught in the door.

## 6 Selecting a Programme and Operating Your Machine

### Control panel

Figure 2

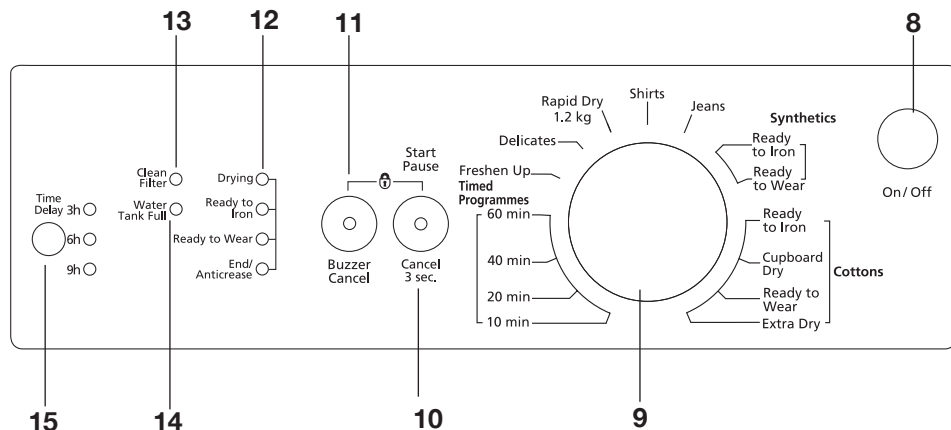

8. On/Off button

9. Programme selection knob

10. Start/Pause/Cancel button

11. Cancel Audio Warning

12. Programme follow-up indicator

13. Filter cleaning warning LED

14. Water tank full warning LED\*

15. Time Delaying Selection Button\*

\* It may change according to the specifications of your dryer

### Turning the machine on

Prepare machine for programme selection by pressing the "On/Off" button.

**i** Pressing the "On/Off" button does not necessarily mean that the programme has started. Press "Start/Pause/Cancel" button of the machine to start the programme.

### Programme selection

Decide the appropriate programme from the table below which includes drying temperature in degrees. Select the desired programme with the programme selection button.

Extra dry	Dry at high temperature only for cotton laundry. Thick and multi layered laundry (E.g.: towels, linens, jeans) are dried in a way that they do not require ironing before placing in the wardrobe.
Cupboard dry	Normal laundry (E.g.: tablecloths, underwear) are dried in a way that they do not require ironing before placing in the drawers.
Ready to wear	Normal laundry (E.g.: tablecloths, underwear) are dried in a way that they do not require ironing before placing in the drawers, but more than those in the Cupboard dry option.
Ready to iron	Normal laundry (E.g., Shirts, dresses) are dried ready to be ironed.

**i** Always select the highest temperature required for drying. High temperature will ensure energy and time saving.

**i** For further programme details, see, "Programme Selection Table"

### **Main programmes**

Depending on the type of textile, the following main programmes are available:

#### **•Cottons**

You can dry your durable clothes with this programme. Dries at a higher temperature. It is recommended to use for your cotton items (such as bed sheets, quilt cover, underclothing, etc.).

#### **•Synthetics**

You can dry your less durable clothes with this programme. It dries at a lower temperature compared to the cottons programme. It is recommended for your synthetic clothes (such as shirts, blouses, synthetic/cotton blended garments, etc.).

**i** Do not dry curtains and lace in your machine.

#### **•Anti-creasing**

A 2-hour anti creasing programme to prevent laundry from creasing will be activated if you do not take the laundry out after the programme has come to an end. This programme rotates the laundry in 60-second intervals to prevent creasing.

### **Special programmes**

For special cases, there are also extra programmes available:

**i** Additional programmes may differ according to the model of your machine.

### **Rapid dry**

You can use this programme to dry cottons that are spun at high speeds in your washing machine. It can dry 1.2 kg Cotton laundry (3 Shirts / 3 T-Shirts) within 30 minutes.

**i** In order to obtain better results from the dryer programmes, your laundry must be washed with a suitable programme and spun at the

recommended spin speeds in your washing machine.

### **Shirt**

Dries shirts in a more sensitive way so that they are less creased and ironed easily.

**i** Shirts may contain little amount of dampness at the end of the programme. It is advised not to leave the shirts in the dryer.

### **Jeans**

You can use this programme to dry jeans or clothing with thick seams that are spun at high speeds in your washing machine.

**i** Review the relevant part of the programme table.

### **•Delicates**

You can dry at a lower temperature your very delicate laundry (silk blouses, fine underwear, etc.) that are suitable for drying or laundry which is advised to be hand-washed.

**i** It is recommended to use a cloth bag to avoid certain delicate garments and laundry from getting creased or damaged. Take your garments immediately out of the dryer and hang them after the programme ends in order to prevent them being creased.





### **•Freshen up**

Only ventilation is performed for 10 minutes without blowing hot air. You can air your clothes that have been kept in closed environments for a long time thanks to this programme to deodorize unpleasant odors.

### **•Timer programmes**

You can select one of the 10 min., 20 min., 40 min. and 60 min. timer programmes to achieve the desired final drying level at low temperatures. Programme dries at the selected time regardless of the drying temperature.

## Programme selection and consumption table

EN				
Programmes	Capacity (kg)	Washing machine spin speed (rpm)	Approximate amount of remaining humidity	Drying time (minutes)
Cottons / Coloreds				
 Cupboard Dry	7	1200-1000	60%	157
		900-800	70%	180
	3.5	1200-1000	60%	90
		900-800	70%	110
 Ready to Wear	7	1200-1000	60%	170
		900-800	70%	190
	3.5	1200-1000	60%	100
		900-800	70%	120
 Ready to Iron	7	1200-1000	60%	115
		900-800	70%	130
	3.5	1200-1000	60%	70
		900-800	70%	90
Rapid Dry	1.2	1200-1000	50%	30
Shirt	1.5	1000-800	50%	59
Jeans	4	1200-1000	50%	110
Synthetics				
 Ready to Wear	3.5	800	40%	70
		600	50%	90
	1.75	800	40%	40
		600	50%	50
Delicates				
 Ready to Wear	1.5	600	50%	40
Energy consumption values				
Programmes	Capacity (kg)	Washing machine spin speed (rpm)	Approximate amount of remaining humidity	Energy consumption value kWh
Cottons Linen Cupboard Dry*	7	1000	% 60	4.48
Cottons Ready to iron	7	1000	% 60	3.6
Synthetics&Mixed fabrics Ready to wear	3.5	800	% 40	1.8

\* : Energy Label standard programme (EN 61121:2005)

All values given in the table have been fixed according to EN 61121:2005 Standard. These values may deviate from the table according to the laundry type, laundry spin speed, environmental conditions and voltage fluctuations.

## Auxiliary function

### Cancel Audio Warning

Your machine will send out an audio warning when the programme comes to an end. If you do not want to hear this sound, you need to press the “Cancel Audio Warning” button. The relevant LED will light up when this button is pressed and an audio warning will not be given when the programme comes to an end.

- i** You can select this function either before or after the programme starts.

### Warning indicators

- i** Warning indicators may differ according to the model of your machine.

### Filter cleaning

A warning LED will light up to remind filter cleaning after the programme finishes.

- i** If the filter cleaning warning LED lights up continuously, please refer to, “Solution suggestions for problems”.

### Water tank (Products equipped with a condenser)

A warning LED will light up at the end of the programme or when the tank is full with water. The machine stops operating when this warning LED lights up during a programme running. To restart the machine, please drain the water in the water tank. Press “Start/Pause/Cancel” button to start the programme after you have emptied the water tank. The warning LED goes off and the programme resumes operating.

### Time delay

If you wish to dry your clothes at a later time, thanks to the time delay function, you can delay the program start up to 3 hours, 6 hours or 9 hours.

1. Open the loading door and put the laundry in.
- i** Make sure that all air outlets are open, door filter is cleaned and the water tank is empty.
2. Set the drying program, temperature, spin speed and, if required, the auxiliary functions.
3. When the time programming button is pressed once, a 3 hour delay is

selected and the relevant led lights.

When the same button is pressed again, 6 hours; and if pressed once more, 9 hours delay will be selected. If the time programming button is pressed one more time, time delaying function will be cancelled. Set the time delay as you require.

4. Delayed operation of the selected program is started by pressing the “Start/Pause/Cancel” button after selecting the time delay.
- i** Additional laundry may be loaded / taken out during the time delay period.

### Canceling the time delay

If you want to cancel the time delay countdown and start the program:

1. Press “Start/Pause/Cancel” button for about 4 seconds. The “:” in the middle of the screen will stop flashing. “Start/Pause/Cancel” light will go off and the remaining time on the screen disappears.
2. Press “Start/Pause/Cancel” button to start the program right away.

## Starting the Programme

1. Press “Start/Pause/Cancel” button to start the programme.
2. “Start/Pause/Cancel” button will light up to indicate that the programme has started.

## Progress of programme

Progress of a running programme is shown through the programme follow-up indicator.

At the beginning of every programme step, the relevant indicator LED will light up and light of the completed step will turn off.

### “Drying”:

- Drying level will be illuminated during the whole drying process until the drying degree reaches “ready to iron”.

### “Ready to iron”:

- Starts to illuminate when the drying degree reaches “ready to iron” step and remains illuminated until the next step.



### “Ready to wear”:

- Starts to illuminate when the drying degree reaches “Ready to wear” step and remains illuminated until the next step.

### “Final / Anti-creasing”:

- Illuminates when the programme comes to an end and anti-creasing function is activated.

**i** If more than one LED light up or flash concurrently, it means there is malfunctioning or a failure (please see, Solution suggestions for problems).

## Changing the programme after the programme has started

You can use this feature after your machine has started to dry your clothes under higher or lower temperatures.

For example;

Press and hold the “Start/Pause/Cancel” button for about 3 seconds to “Cancel” the programme in order to select “Extra Dry” programme instead of “Iron Dry” programme.

Select the “Extra Dry” programme by rotating the programme knob.

Press “Start/Pause/Cancel” button to start the programme.

**i** The programme which is selected first will go on even if the programme selection button is moved and another programme mode is selected while the machine is operating. You must cancel the ongoing programme in order to change the drying programme. (See. Ending the programme through cancelling)

## Adding/removing laundry in standby mode

In order to add or take out laundry after the start-up of the programme;

1. Press the “Start/Pause/Cancel” button to switch the machine to “Pause” mode. Drying process will stop.
2. Open the door at “Pause” position and close it again after adding or taking out laundry.
3. Press “Start/Pause/Cancel” button to

start the programme.

**i** Any laundry added after the drying process has started may cause the already dried clothes in the machine to intermingle with wet clothes and the drying result will not be as good.

**i** Laundry may be added or taken out as much as desired during a drying process, but as this process will interrupt drying continuously, it will extend the programme duration and increase energy consumption. Therefore, it is recommended to add laundry before the drying programme is started.

## Child-proof lock

There is a childproof lock to prevent any programme interruption due to the pressing of keys while the programme is on. The loading door and all keys except the “On/Off” key on the panel are deactivated when the child-proof lock is active.

In order to activate the childproof lock, press on the “Start/Pause/Cancel” and “Cancel audio warning” buttons simultaneously for 3 seconds.

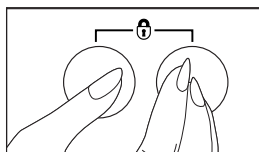

To start a new programme after the programme is over or to interrupt the programme, the childproof lock should be deactivated. To deactivate the child-proof lock, press the same buttons again for 3 sec.

**i** 2 beeps when activating and 1 beep when deactivating the child-proof lock is heard.

## Ending the programme through canceling

The programme which is selected first will keep on going even if the position of the programme selection button is changed. A new programme can be selected and started after “Programme cancel” is

activated in order to change the drying programme.

To cancel any selected programme;

- Press “Start/Pause/Cancel” button for about a duration of 3 seconds. The “Filter cleaning”, “Water tank” and “End/ Anti-creasing” warning LEDs will light up at the end of this period for reminding purposes.



 As the inside of the machine will be excessively hot when you cancel the programme while the machine is running, activate the ventilation programme to cool it down.

 When your machine is stopped while running any of the programmes; if the position of the programme selection knob is changed, then an audio warning will be heard since the running programme is not cancelled (provided that the "Cancel audio warning" function is not selected). Machine will not operate even the "Start/Pause" button is pressed, unless it is returned to the previously

running programme. You must cancel the ongoing programme in order to change the drying programme.

## End of programme

The “End/Anti-creasing”, “Filter cleaning” and “Water tank” warning LEDs on the programme follow up indicator will light up when the programme comes to an end. The door can be opened and the machine becomes ready for a second cycle. Press the “On/Off” button to shut down the machine.

-  A 2-hour anti creasing programme to prevent laundry from creasing will be activated if you do not take the laundry out after the programme has come to an end.
-  Clean the filter after each drying (please see, Filter cleaning).
-  Drain the water tank after each drying (please see, Water tank)

## Technical Specifications

EN

Height (adjustable)	85.0 cm
Width	59.5 cm
Depth	54 cm
Capacity (max.)	7 kg
Weight (net)	38 kg
Voltage	See type label
Rated power input	
Model code	

Type label is located behind the loading door.



This appliance's packaging material is recyclable. Help recycle it and protect the environment by dropping it off in the municipal receptacles provided for this purpose. Your appliance also contains a great amount of recyclable material. It is marked with this label to indicate the used appliances that should not be mixed with other waste.

 This way, the appliance recycling organised by your manufacturer will be done under the best possible conditions, in compliance with European Directive 2002/96/EC on Waste Electrical and Electronic Equipment. Contact your town hall or your retailer for the used appliance collection points closest to your home. We thank you doing your part to protect the environment.

## 7 Quick instructions for daily use

---

### Preparation and starting

1. Press the “On/Off” button.
2. Place the laundry in the machine.
3. Select the programme.
4. Close the loading door.
5. Press “Start/Pause/Cancel” button.

### Cancelling a programme

A new programme can be selected and started after “Programme cancel” is activated in order to change the drying programme.

In order to cancel the selected programme, press “Start/Pause/Cancel” button for about 3 seconds. The “Filter cleaning”, “Water tank” and “End/ Anti-creasing” warning LEDs will light up at the end of this period for reminding purposes.

### Adding laundry

In order to add laundry after the start-up of the programme:

1. Press “Start/Pause/Cancel” button.
2. Open the loading door and put the laundry in.
3. Close the loading door.
4. Press “Start/Pause/Cancel” button to start the programme.

### Changing the programme after the programme has started

You can use this feature after your machine has started to dry your clothes under higher or lower temperatures. Press and hold the “Start/Pause/Cancel” button for about 3 seconds to switch the machine into the “Cancel” status in order to change the programme. Change the programme and press “Start/Pause/Cancel” button to start it.

### After the programme is finished

The “End/Anti-creasing” and “Filter cleaning” warning LEDs as well as “Water tank” warning LED in some models on the programme follow up indicator will light up when the programme comes to an end. The door can be opened and the machine becomes ready for a second cycle.

1. Press the “On/Off” button to shut down the machine.
2. Take out the laundry from the machine.
3. Check if there are any foreign substances in the machine.
4. Clean the filter after drying. Also drain the water tank in models equipped with a condenser.

## 8 Maintenance and cleaning

### Cover filter

Lint and fibres released from the laundry to the air during the drying cycle are collected in the "Cover Filter".

**i** Such fibre and lint are generally formed during wearing and washing.

**i** Always clean the filter after each Drying process.

**i** You can clean the filter and filter area by vacuum cleaner.

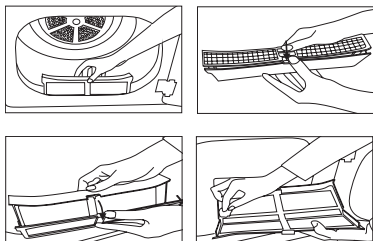

For Filter cleaning;

- 1 Take out the cover
- 2 Remove the cover filter by pulling it up and open the filter.
- 3 Clean lint, fibre, and cotton raveling by hand or with a soft piece of cloth.
- 4 Close the filter and place it back into its seat.

### Sensor (models equipped with a sensor)

There are humidity sensors in your machine that detect whether the laundry is dry or not.

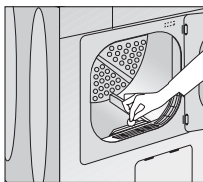

For sensor cleaning;

- 1 Open the cover of your machine.
- 2 Allow the machine to cool off if drying has been carried out.
- 3 Wipe the metal sensors with a soft cloth, dampened with vinegar and dry them.

**i** Clean metal sensors 4 times a year.

**⚠** Never use solvents, cleaning agents or substances alike when cleaning as these might cause fire and explosion!

### Water tank (Products equipped with a condenser);

The moisture in the damp laundry is taken from the laundry and condensed. Drain the water tank after each drying cycle or during drying when "Water tank" warning LED comes on.

**⚠** Condensed water is not drinkable!

**i** You can use the water in the water tank in your steam irons or air humidifiers.

**⚠** Never take out the water tank when the programme is running!

Water tank may be located in two different places as indicated below, depending on the model of your machine.

- Inside the drawer on the panel
- Inside the kick plate cover

If you forget to drain the water tank, your machine will stop during the following drying cycles when the water tank is full and the "Water tank" warning LED will light on. If this is the case, press the "Start/Pause/Cancel" button to resume the drying cycle after draining the water tank.

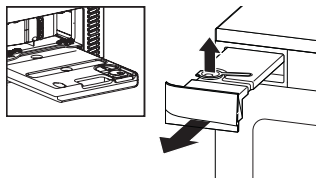

In order to drain the water tank;

- 1 Carefully remove the water tank by opening the kick plate cover/pulling the drawer.
- 2 Drain the water by opening the water tank cover.
- 3 If there is lint accumulation in the water tank cover, clean it and press to close.
- 4 Place the water tank into its seat.

## For the condenser (products equipped with a condenser);

Hot and humid air in the condenser is cooled with the cold air from the room. Thus, the humid air circulating in your machine is condensed and then pumped into the tank.

**i** Clean the condenser after every 20 drying cycles or once a month.

To clean the condenser;

- 1 If a drying process has been carried out, open the door of the machine and wait until it cools down.
- 2 Unlock the 4 condenser locks after opening the kick plate.
- 3 Pull out the condenser.
- 4 Clean the condenser with pressurized water and wait until the water drains.
- 5 Replace the condenser with the side labeled "Top" facing upwards. Lock the 4 condenser locks. Make sure that the red lock on the upper right corner is engaged securely.
- 6 Close the kick plate cover.

Close properly and check the locking latches?

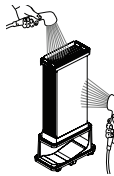
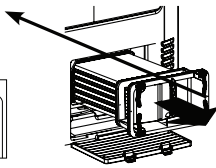

## 9 Solution suggestions for problems

Problem	Cause	Explanation / Suggestion
Drying process takes too much time.	Cover filter and filter drawer might have not been cleaned.	* Clean the cover filter and Filter drawer.
Laundry come out wet at the end of drying.	* Cover filter and filter drawer might have not been cleaned. * Excessive laundry might have been loaded in.	* Clean the cover filter and Filter drawer. * Do not overload the machine.
Machine does not switch on or the programme does not start. Machine is not activated when set.	* It might have not been plugged in. * The loading door may be ajar. * Programme might have not been set or the "Start/Pause/Cancel" button might have not been pressed. * "Childproof lock" might have been activated. * The condenser cover on the models with a condenser might not be closed securely.	* Make sure that the machine is plugged in. * Make sure that the loading door is properly closed. * Make sure that the programme has been set and it is not in "Pause" mode. * Deactivate the childproof lock. * Make sure that the condenser cover and the red lock is closed securely.
Programme has been interrupted without any cause.	* The loading door may be ajar. * Electricity may be cut off.	* Make sure that the loading door is properly closed. * Press "Start/Pause/Cancel" button to start the programme.
Laundry has shrunk, become felted or deteriorated.	* A programme suitable for the laundry type might have not been used.	* Dry only the laundry which is suitable for drying in your machine after checking the labels on your clothes. * Select a programme with suitable low temperature for the laundry type to dry your clothes.
Drum lightning does not come on. (for models equipped with a lamp)	* The machine might have not been started by using the On/Off button. * Bulb may have blown.	* Make sure that the machine is On. * Call the authorized service to replace the bulb.
"Final / Anti-creasing" LED flashes.	* The 2-hour anti creasing programme to prevent laundry from creasing might have been activated.	* Turn off the machine and take out the laundry.
"Final / Anti-creasing" LED is on.	* Program has come to an end.	* Turn off the machine and take out the laundry.
The "Drying" LED flashes.	* A heat sensor failure has occurred. Machine ends the programme without heating.	* Turn off the machine and take out the laundry. Call your authorized service.
"Filter cleaning" LED flashes.	* Filter might have not been cleaned.	* Clean the cover filter.
Also for products equipped with a condenser		
"Water tank" warning LED is on.	* Water may be full. * Anti-creasing programme might be running.	* Drain the water in the water tank.
"Condenser cleaning" LED is on.	* Filter drawer/Condenser might have not been cleaned.	* Clean the filters in the condenser/filter drawer under the kick plate.

⚠ Call an authorized service agent if the problem persists.

## 10 Door Reversal

1. Unplug the dryer.
2. Open the door.
3. Turn the contact pin in the upper part of door by 90° in the anti-clockwise direction and remove it.
4. Unscrew the 2 screws of each door hinge and remove the door.
5. Removing the door lock: Using a flat screwdriver release the snap-fitted door lock.
6. Remove 2 plugs for the hinges and one for the door-lock on the opposite side.
7. Insert the door lock system on the opposite side of the hinge and be sure it is properly fitted.
8. Reverse the door:

Fit the door on the opposite side using 4 screws removed. Fix the contact pin into the top side of the door by turning 90° in the clockwise direction.

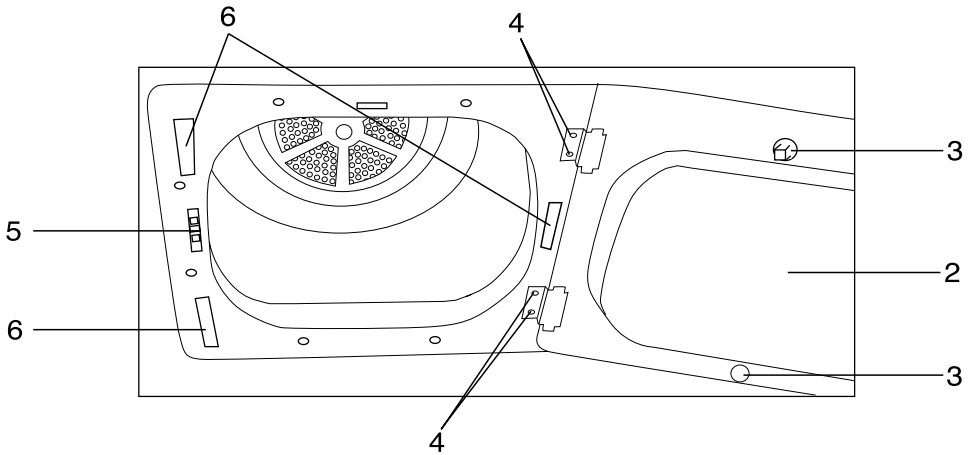

## 11 Guarantee

---

Your new product is guaranteed against the cost of breakdown repairs for twelve months from the date of the original purchase.

### What is covered?

- Repairs necessary as a result of faulty materials, defective components or manufacturing defect.
- The cost of functional replacement parts, but excluding consumable items.
- The labour costs of a approved repairer to carry out the repair.

### What is not covered?

- Transit, delivery or accidental damage or misuse and abuse.
- Cabinet or appearance parts, including knobs, flaps, handles or container lids.
- Accessories or consumable items including but not limited to, ice trays, scrapers, cutlery baskets, filters and light bulbs.
- Repairs required as a result of unauthorised repair or inexpert installation that fails to meet the requirements contained in the user instruction book.
- Repairs to products used on commercial or non-residential household premises.
- Loss of frozen food in freezers or fridge/freezers. (Food loss insurance is often included within your household contents insurance policy, or may be available separately from your retailer).

### Important notes

- Your product is designed and built for domestic household use only.
- The guarantee will be void if the product is installed or used in commercial or non-residential domestic household premises.
- The product must be correctly installed, located and operated in accordance with the instructions contained in the User Instructions Booklet provided.
- Professional installation by a qualified

Electrical Domestic Appliance Installer is recommended for all Washing Machines, Tumble Dryers, Dishwashers, Dryers and Electric Cookers

- Gas Cookers must only be installed by a CORGI (or BORD GAIS) registered Gas Installer.
- The guarantee is given only within the boundaries of the United Kingdom and the Republic of Ireland.
- The guarantee is applicable only to new products and is not transferable if the product is resold.
- disclaims any liability for incidental or consequential damages.
- The guarantee does not in anyway diminish your statutory or legal rights.



## 12 Service

Please keep your purchase receipt or other proof of purchase in a safe place; you will need to have it should the product require attention under guarantee.

You should also complete the details below; it will help us assist you when requesting service. (The model number is printed on the Instruction Booklet and the serial number is printed on the Rating Label affixed to the appliance)

---

Model No:

---

Serial No:

---

Retailer:

---

Date of purchase:

---

### Republic of Ireland

All Refrigeration, 01 862 3411

All Cookers

Washing Machines & Dryers, Tumble

Dryers Dishwashers

Before requesting service please check the trouble-shooting guide in the Operating Instructions as a charge may be levied where no fault is found even though your product may still be under guarantee.

### Service once the manufacturers guarantee has expired.

If you have purchased an extended guarantee please refer to the instructions contained within the extended guarantee agreement document. Otherwise please call the appropriate number above where service can be obtained at a charge. Should you experience any difficulty in obtaining service please contact the Customer Help-Line.

Tel: 0845 600 4911

For service under guarantee simply telephone the appropriate number below.

e-mail: [service@beko.co.uk](mailto:service@beko.co.uk)

### UK Mainland & Northern Ireland

Fridges & Freezers 0845 600 4903

Electric Cookers 0845 600 4902

Gas & 0845 600 4905

Dual Fuel Cookers

Washing Machines & Dryers

Tumble Dryers 0845 600 4906





# BEKO



**Beko plc Beko House, Caxton Way, Watford  
Hertfordshire, WD18 8UF**

Tel: 0845 6004911

Fax: 0845 6004922

Email: [service@beko.co.uk](mailto:service@beko.co.uk)

[www.beko.co.uk](http://www.beko.co.uk)